



## 2ml middle boronsilicon ampoule pharmaceutical packing airless vial ampoule bottle

Our Product Introduction

for more products please visit us on [molecularsievepowder.com](http://molecularsievepowder.com)

### Basic Information

- Place of Origin: Jiangsu, China
- Brand Name: huagui
- Model Number: ampoule bottle
- Minimum Order Quantity: 1000 pieces
- Price: \$0.02/pieces 1000-9999 pieces
- Packaging Details: Carton package size:45\*30\*22.5cm for 2ml 3ml bottle,45x30x32cm for 5,7ml,45x30x33cm for 10ml,45x30x34cm for 12ml,45x30x36cm for 15 20 30 ml  
Qty: (2ml) 3180pieces,(3ml) 2650 pieces, (5ml) 2280 pieces,(7ml) 1995pieces,(10ml) 1710pieces (12ml,15ml) 1425p
- Supply Ability: 50000 Piece/Pieces per Day 2ml middle boronsilicon ampoule pharmaceutical packing airless via



### Product Specification

- Surface Handling: Screen Printing
- Industrial Use: Chemical
- Base Material: Borosilicate Glass, Glass
- Body Material: Borosilicate Glass, Glass
- Collar Material: Borosilicate Glass, Glass
- Sealing Type: Dropper
- Use: Other Chemical
- Material: Clear Glass Ampoule Bottle For Pharmaceutical Serum Injection
- Volume: 2ml,3ml,5ml,7ml,10ml,12,ml,15ml,20ml,30ml
- Product Name: 2ml Middle Boronsilicon ampoule pharmaceutical Packanging Airless Vial A
- Cap Type: On-demand
- Sample: Free 2-5pieces
- Feature: Eco-friendly Recyclable



### More Images

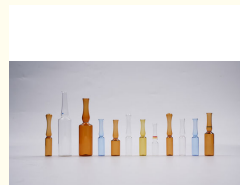

### Product Description

Our Pro

OEM/ODM

# AMPOULES

Material stability/good sealing/high transmittance

MOLECULAR SIEVE POWDER CO., LTD. IS A LEADING MANUFACTURER OF MOLECULAR SIEVES AND ADSORBENTS IN CHINA. WE HAVE BEEN IN THE MARKET FOR OVER 20 YEARS. OUR PRODUCTS ARE OF HIGH QUALITY AND HAVE BEEN EXPORTED TO OVER 100 COUNTRIES. WE WELCOME VISITORS FROM ALL OVER THE WORLD. CONTACT US AT: MOLECULAR SIEVE POWDER CO., LTD. TEL: +86 371 6381 1111 FAX: +86 371 6381 1112 EMAIL: [info@mspowder.com](mailto:info@mspowder.com) WWW.MOLECULARSIEVEPOWDER.COM





**SCIENTIFIC  
RESEARCH UNITS**



**PHARMACEUTICAL COMPANIES**



**FOOD FACTORY**



**THE BEAUTY INDUSTRY**

## **PRODUCT PARAMETERS**

Taixing Huagui New Packing Materials Co., Ltd.



### CFDA Type Ampoules Series

ml	d1	d2	d3	h1(B	C	D)	h4	s2	s3	v(ml)
1ml	10.75	6.5	6	60	67	70	25.5	0.37	0.3	1.5
2ml	10.75	6.5	6	72	79	83	37.5	0.37	0.3	2.3
3ml	12.75	6.5	6	75	82	89	39.5	0.37	0.3	3.5
5ml	14.75	7	7	83	90	95	46.5	0.40	0.4	5.5
10ml	17.75	7.5	7.1	102	109	112	62	0.47	0.4	11.5
20ml	22.5	8.5	7.8	113	120	126	76	0.50	0.5	23.5

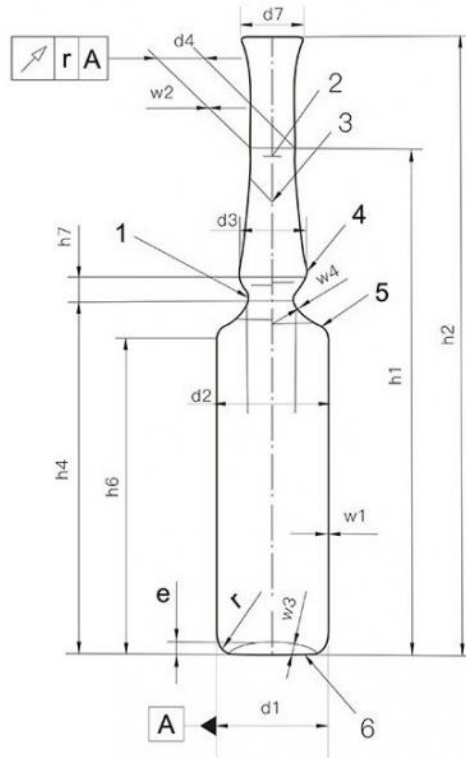

#### FORM:C

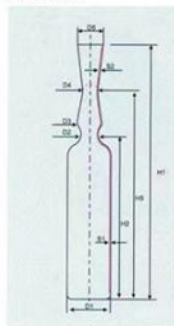

#### International Standard ISO9187-1:2000

Volume	1ML	2ML	3ML	5ML	10ML	20ML	25ML	30ML
D1	10.75 ±0.15	10.75 ±0.15	12.75 ±0.15	14.75 ±0.15	17.75 ±0.20	22.5 ±0.25	22.5 ±0.25	22.5 ±0.25
D2	6.5 ±0.50	6.5 ±0.50	6.5 ±0.50	7.0 ±0.50	7.5 ±0.60	8.5 ±0.80	8.5 ±0.80	8.5 ±0.80
D3	6.5 ±0.50	6.5 ±0.50	6.5 ±0.50	7.0 ±0.50	7.5 ±0.60	8.5 ±1.0	8.5 ±1.0	8.5 ±1.0
D4	6.0 ±0.50	6.0 ±0.50	6.0 ±0.50	7.0 ±0.50	7.1 ±0.60	7.8 ±0.80	7.8 ±0.80	7.8 ±0.80
D5	9.0 ±0.8	9.0 ±0.8	10.7 ±0.8	12.2 ±1.0	13.0 ±1.0	14.0 ±1.0	14.0 ±1.0	14.0 ±1.0
H1	67.0 ±1.0	79.0 ±1.0	82.0 ±1.0	90.0 ±1.0	109.0 ±1.0	120.0 ±1.5	135.0 ±1.5	150.0 ±1.5
H2	25.5 ±0.50	37.5 ±0.50	39.5 ±0.50	46.5 ±0.50	62.0 ±1.0	76.0 ±1.3	91.0 ±1.3	106.0 ±1.3
H5	47.0 ±2.0	57.0 ±2.0	62.0 ±2.0	68.0 ±2.0	87.0 ±2.0	100.0 ±2.0	115.0 ±2.0	130.0 ±2.0
S1	0.5 ±0.03	0.5 ±0.03	0.5 ±0.03	0.55 ±0.03	0.6 ±0.04	0.7 ±0.04	0.7 ±0.04	0.7 ±0.04
S2	0.37 ±0.05	0.37 ±0.05	0.37 ±0.05	0.42 ±0.05	0.47 ±0.05	0.55 ±0.05	0.55 ±0.05	0.55 ±0.05

D1: Body diameter  
D2: Constriction diameter  
D3: Bulb diameter  
D4: Stem diameter  
D5: Funnel diameter

H1: Total Height  
H2: Constriction height  
H5: Sealing height

S1: Body wall thickness  
S2: Stem wall thickness

FORM-D

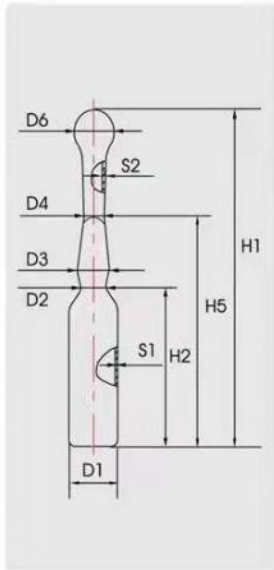

Volume	1ml	2ml	3ml	5ml
D1	10.75 ±0.15	10.75 ±0.15	12.75 ±0.15	14.75 ±0.15
D2	6.5 ±0.5	6.5 ±0.5	6.5 ±0.5	7 ±0.5
D3	8.5 ±0.5	8.5 ±0.5	8.5 ±0.5	9 ±0.5
D4	6 ±0.35	6 ±0.35 <sup>n</sup>	6 ±0.35	7 ±0.35
D6	10 ±1	10 ±1	10.5 ±1	12 ±1
H1	70 ±1	83 ±1	89 ±1	95 ±1
H2	25.5 ±0.5	37.5 ±0.5	39.5 ±0.5	46.5 ±0.5
H5	47 ±2	57 ±2	62 ±2	68 ±2
S1	0.5 ±0.03	0.5 ±0.03	0.5 ±0.03	0.55 ±0.03
S2	0.37 ±0.05	0.37 ±0.05	0.37 ±0.05	0.4 ±0.05

# DETAILS SHOW

Taixing Huagui New Packing Materials Co., Ltd.



## GLASS

The material is transparent, glossy and bright.

## BOTTLE

Reasonable design, smooth and transparent surface, color can be selected according to personal preference

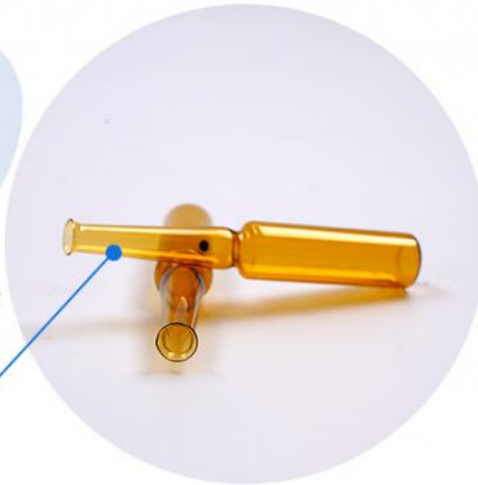

## APPLICATION

Easy breakable and smooth ending



Excellent Quality



Good Price



Delivery on time



Various Items



Warmly Service

## WHY CHOOSE US?

The company has more than 10 years experience.

Small and flexible MOQ as well as short lead time

Personalized Customization to Create Unique Products

Quality Assurance of Various Products

Strict quality control and 24 hours after-sale service

## ORDER PROCESS

**1** Send Inquiry & Choose Product

**2** Generate Order & Complete Payment



**3** Send Design File or Sketch

**4** Confirm Design

**5** Start Production

**6** Receive Delivery



## COMPANY INTRODUCTION

Taixing Huagui New Packing Materials Co., Ltd.



### Our Company

Taixing Huagui new packing materials co.,Ltd is a professional manufacturer of many glass products. (Perfume Bottle,reed Diffuser,Cosmetic Glass bottle, Honey jar etc..) The company located in Taixing city,Jiangsu province,covering an area of more than 8000m2. the company has 32 automatic production lines with a daily production capacity of 200000pcs.

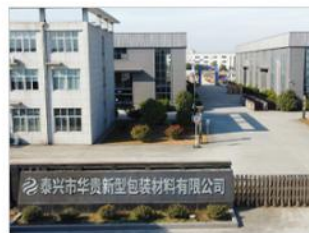

### Our Factory

our goods are exported to more than 40 countries around the world. the customer first and quality is life of the factory is always our first principle and welcome you to our factory and be our best partners. Sincerely hope we have this chance to cooperate with you!

## COMPANY STRENGTH

We have multiple production lines

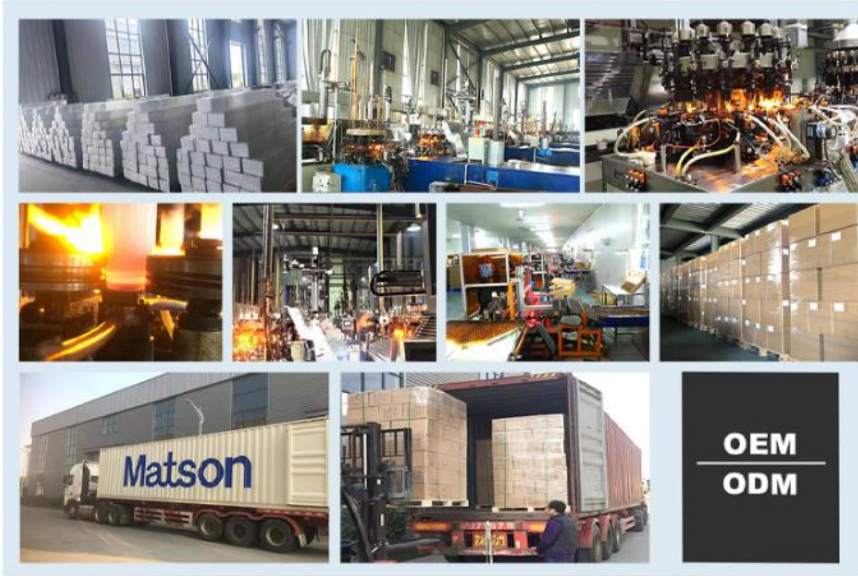

## EXHIBITION





CERTIFICATE



EXPRESS SHIPPING

TRADE ASSURANCE

- ◆ 100% Refund of trade assurance amount
- ◆ Maintain the time and quality of arrival
- ◆ Keep your transaction more safe



Before shipment, our QC will check our customer's product one by one. Besides, we use standard export carton or we pack according to the requirements of our customers.

Trade assurance  
Western union, T/T, L/C,  
PayPal

Air transport, Ocean Shipping,  
Land transportation, Express



FAQ

Q1 What terms of payment you use? T/T, L/C, Western Union. Q2. What is your sample fee? How to order your sample? For samples, if no logo & no color required, we can supply free samples, you undertake freight. If you want to customize your logo, we need to charge you sample mold fee, details, please contact us. Q3. How long is your sample time? How is your mass production time? 5A. For customized sample, 3-7 days. For mass production, 20-35 days depends on quantity. Q4 Does this product have available stock? The products under "Ready To Ship Bottles" group we have stock. The products under other group, please send me inquiry to confirm. Q5 What material is this product? All our bottle is made of high grade crystal-like glass material. Q6 Do you provide screen printing and labeling service? Yes. According to the AI file you provide, then customize it. Q7 What customization service do you offer? Bottle design and color, Atomizer type and color, Cap design and color, Box Logo, Customer package, Other. Q8 What's your Warranty? 1) we can make sure product quality as samples or which you confirmed. 2) Please contact us whenever issues confirmed and we would try our best to cooperate with you. Q9. What is your MOQ? Depends on your detail requirement, normally 10000pcs, please contact us for details.



SHANGHAI DESIKENSHI MOLECULAR SIEVE CO.,LTD

☎ 13299345678

✉ 13299345678@163.com

🌐 [molecularsievepowder.com](http://molecularsievepowder.com)

6 Xinjian Sub Rd, Songjiang Area, Shanghai China